

# Daily cleaning

## Schaerer Coffee Vito



Refer to the safety instructions and to the chapter „Cleaning“ inside the user manual!

**CAUTION!**  
User at risk!



Never reach into the machine or under the beverage outlets during the automatic cleaning!

**CAUTION!**  
Machine at risk!



Never use force, strong pressure or sharp objects on the Touch Screen!

### Cleaning Menu

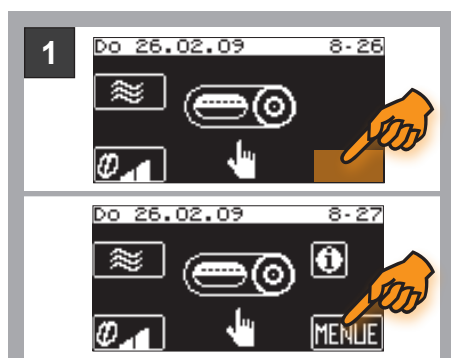

Depending on the status of the machine, the display might show alternative information.

- ▶ Press on the indicated area.
- ▶ Press **MENUE**.

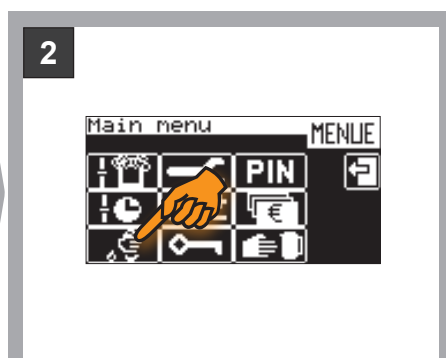

- ▶ Press on the cleaning symbol
- The menue „Customer Care“ with all available programs appears.

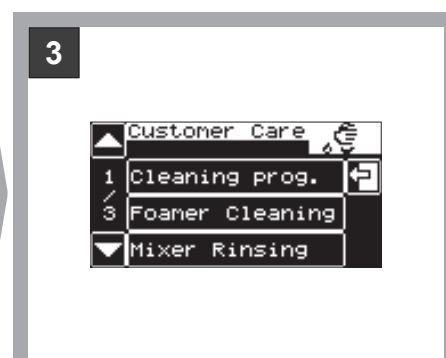

- ▶ Select any required program.

### Cleaning Program (withk milk / without milk)

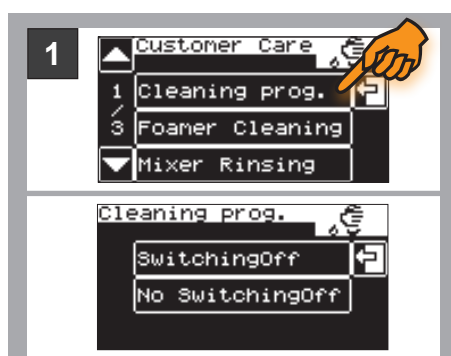

- ▶ Select Cleaning Program.
- ▶ Make a selection in the following menu (switch off / resume operation).

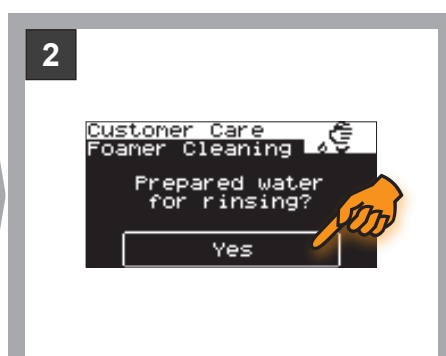

- Option 1: Machine without drainage**
- ▶ Place a suitable container under the outlet (capacity: ± 1 litre).
- Option 2: Machine with drainage**
- ▶ Move the outlet to the lowest position.
  - ▶ Press **Start**.

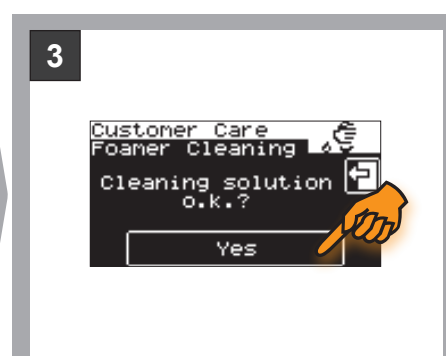

- Option 1: with milk**
- ▶ See **6**.
- Option 2: without milk**
- ▶ Mix 25 ml detergent (Milkpure or Daypure) and 500 ml **cold** water in a cleaning container.
  - ▶ Place the milk hose (including nozzle) into the cleaning solution.
  - ▶ Press **Yes**.
  - Cleaning process is running.

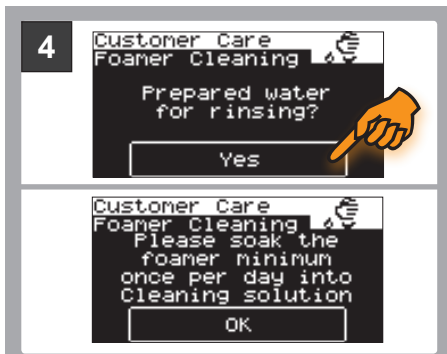

- ▶ Fill the cleaning container with ± 400 ml of fresh water.
- ▶ Place the milk hose (including nozzle) into the cleaning solution.
- ▶ Press **Yes**.
  - Rinsing process is running.
  - Request for foamer head cleaning appears.

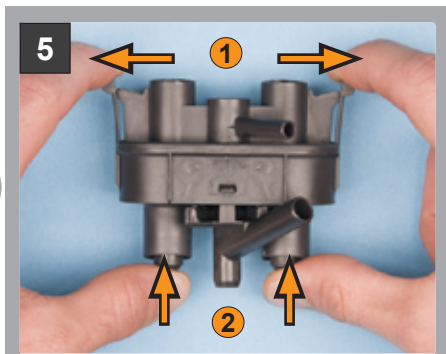

- ▶ Disassemble foamer head.
- ▶ Place the parts (together with the milk hose) for ± 30 minutes in a solution of 500 ml **hot** water and 25 ml cleaning agent (Milkpure or Daypure).
- ▶ Rinse the parts thoroughly under running (hand) warm water.
- ▶ Re-install the parts.
- ▶ Press **OK**.

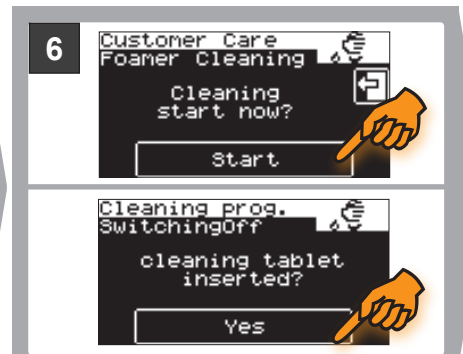

- ▶ Press **Start**.
- ▶ Follow the instructions on the touch screen.
- ▶ Insert cleaning tablet.
- ▶ Press **Yes**.
  - Cleaning process is running.
  - Cleaning process is completed and will be quit automatically.

## Foamer cleaning

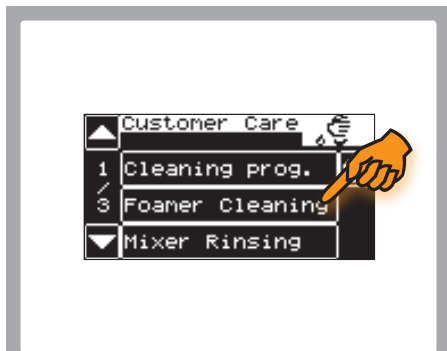

- i** Die Schaumerreinigung muss nur bei Maschinen mit Frischmilch durchgefuhrt werden!
- ▶ Press Foamer Cleaning.
  - ▶ See **2** to **5** of the Cleaning Program.
    - Foamer Cleaning process is completed and will be quit automatically.

## Mixer Rinsing

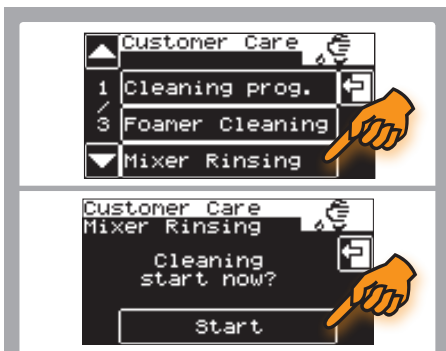

- ▶ Press Mixer Rinsing.
- ▶ Press **Start**.
  - Mixer Rinsing process is running.
  - Mixer Rinsing process is completed and will be quit automatically.

## Machine surfaces

- ▶ Wipe the machine surfaces with a damp (paper) tissue after the cleaning process.



**CAUTION!**  
Do not use any abrasives!

**CAUTION!**  
User at risk!



### Hygiene Vorschriften nach HACCP einhalten! Auszug von HACCP:

- Never refill milk container. Always throw leftovers away.
- Always clean the milk container before filling it with fresh milk.
- Fill up with fresh milk, chilled to 3 °C - 5 °C, just before restarting the machine.
- Use pasteurized or ultra high temperature treated (UHT) milk! Do not use raw milk! The milk must be homogenised!
- For optimum hygiene use a milk cooler (optional) to maintain milk temperature.
- If equipped the refrigerator / cool-ing unit (optional) must be cleaned at least once a week!